

STANDING SEAM

INTERNAL CORNER BARGE FLASHING

Cladco Internal Corner Barge Flashings are used in the application of our Standing Seam Sheets as cladding or roofing. Our Internal Corner Barge Flashings seal off your internally facing corners, to create a protected and professional finish.

COLOUR RANGE



FLASHING SPECIFICATIONS

Length	3m
Dimensions	120mm x 120mm
Thickness	0.7mm
External Finish	GreenCoat® Pural BT

TEST CERTIFICATIONS

Quality	CE Marked (BS EN 14783:2013)
Fire Rating	Class A1 (BS EN 13501)

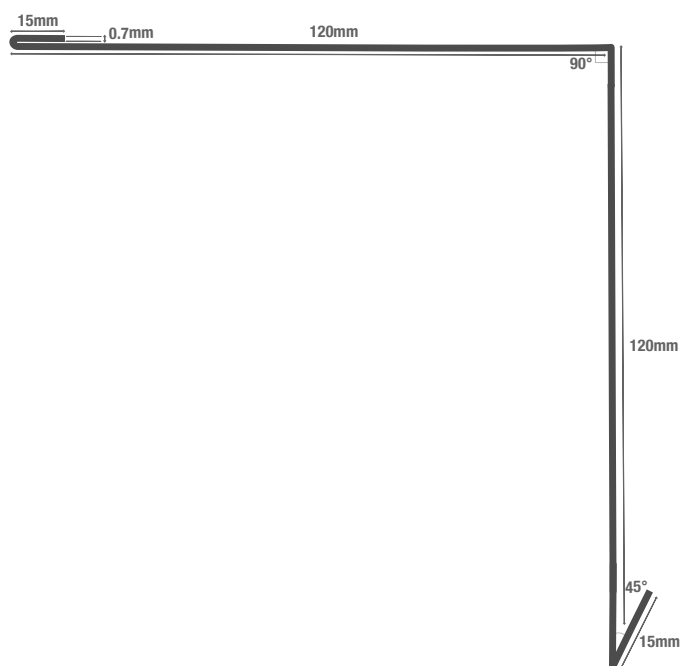

STANDING SEAM FLASHINGS FOR CLADDING

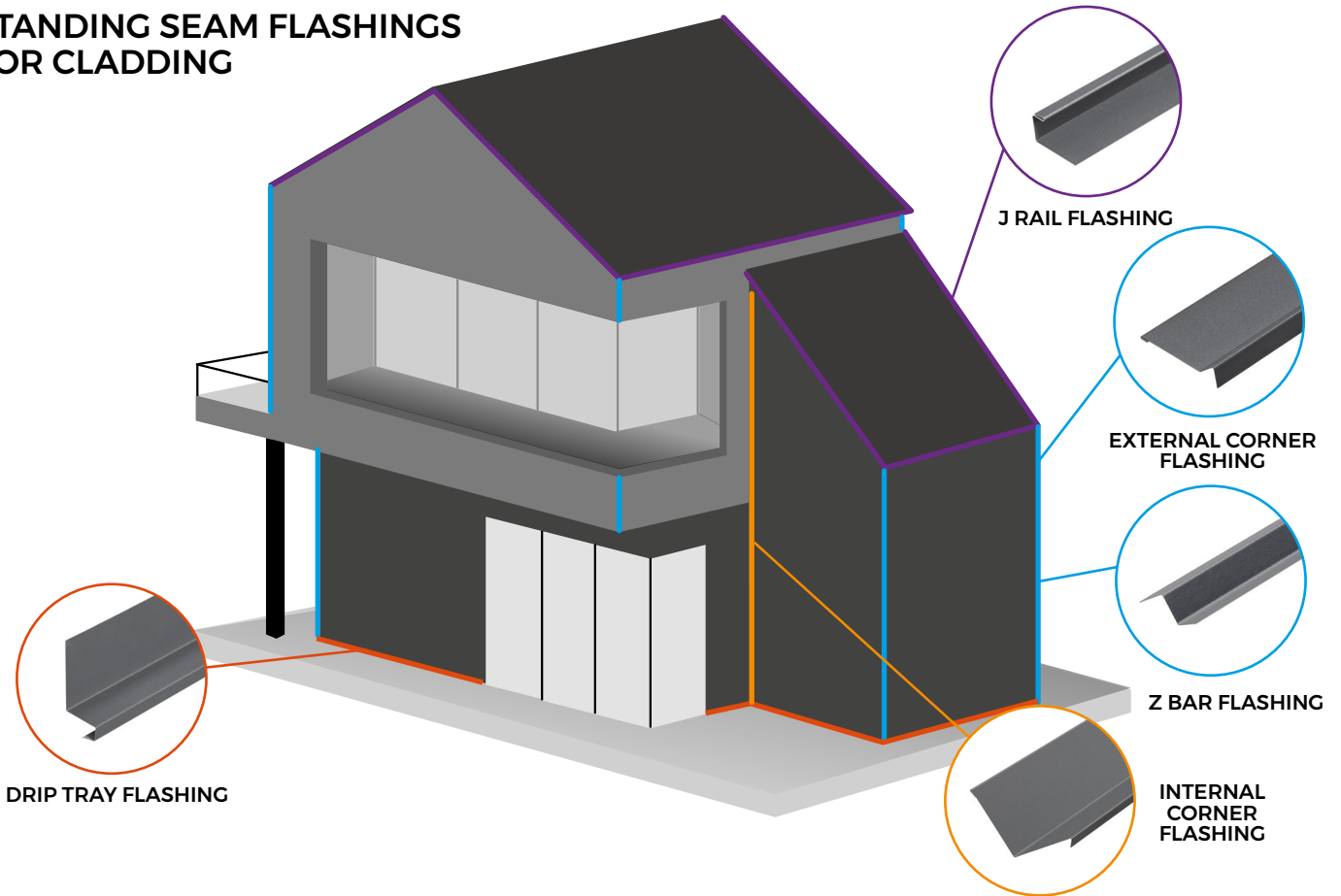

STANDING SEAM FLASHINGS FOR ROOFING

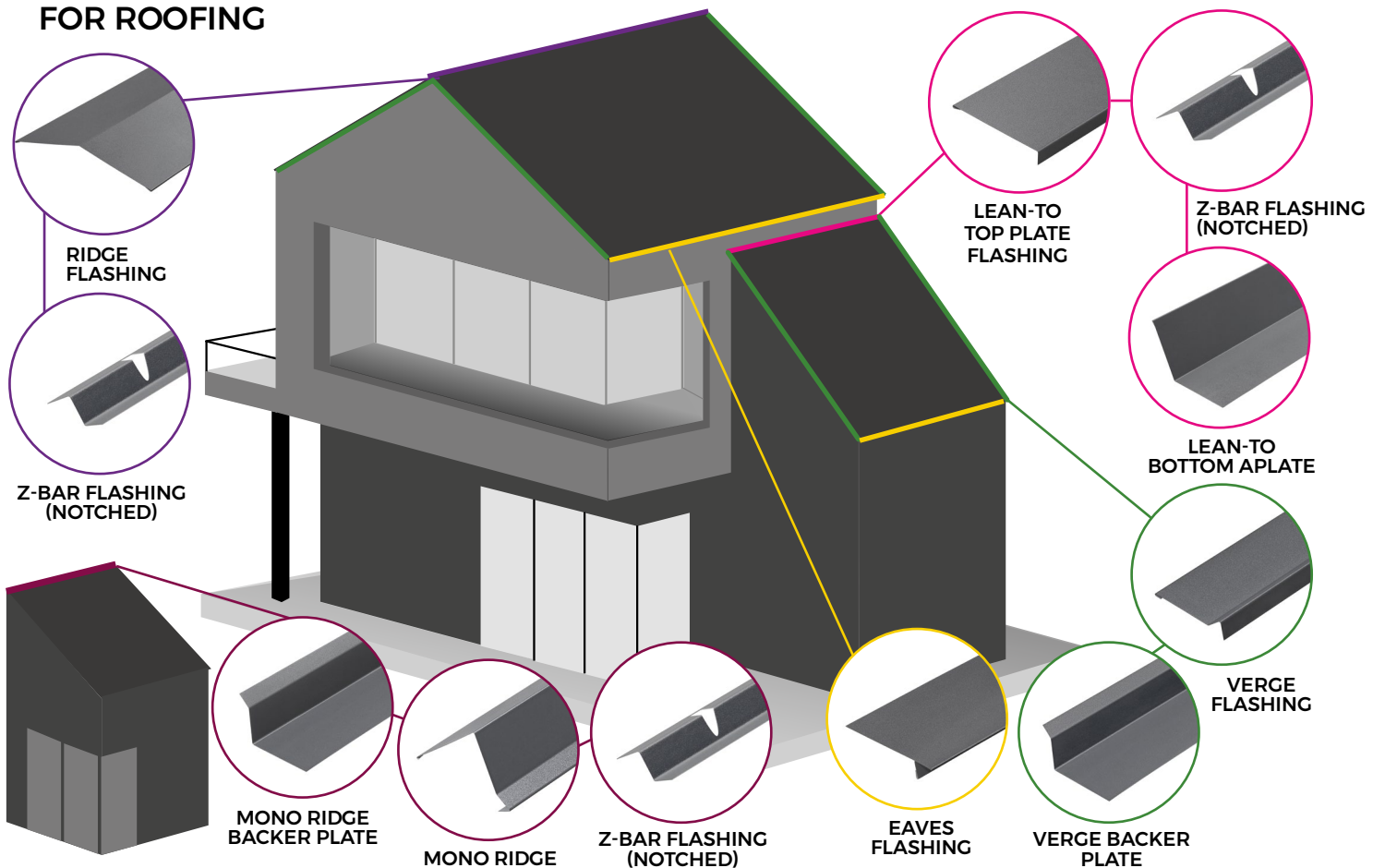

SUSTAINABLE MATERIALS

Cladco Standing Seam Roofing Sheets are manufactured from SSAB Steel coated with GreenCoat® Pural BT. The use of Swedish rapeseed oil, in place of traditional fossil fuel oils, promotes sustainable production methods which reduce our environmental footprint to provide you with a high-quality, A1 fire-rated roofing and cladding product.

AFTERCARE

Standing Seam Roof Sheets and low-maintenance and require little in the way of upkeep. We recommend, however, that annual inspection of the Sheeting is carried out, and any debris or dirt build up is removed or cleaned away.



Sustainable Coating Made From Swedish Rapeseed Oil



Made From High-Quality SSAB Nordic Quality Steel



Scratch, Corrosion And Weather Resistant Surface



Installation With Seaming Pliers



MATERIALS

Nordic quality, sustainable SSAB steel promotes sustainable production.



SURFACES

A durable GreenCoat® Pural BT coating with a matt finish, with or without ribs.



ACCESSORIES

Corner Barge Flashings are installed with Z-Bars and a range of our Standing Seam Flashings for a sleek finish.



RESISTANCE

Pural BT coated Sheets are weather, corrosion, scratch and UV resistant.



GUARANTEE

Sheets have a long life span of up to 50 years.

PRODUCT ACCESSORIES

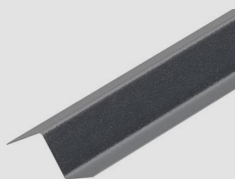

Z-BAR FLASHING



TIN SNIPS



CTI ADHESIVE AND SEALANT



ANNULAR RING NAILS



VENT 3 PRO BREATHABLE MEMBRANE

TOOLS REQUIRED



SEAMING PLIERS



HANDHELD CIRCULAR SAW



RUBBER Mallet

For a full list of tools required, please refer to our Standing Seam Installation Guide.

www.cladco.co.uk

T: 01837 659901 E: info@cladco.co.uk

CLADCO
PROFILES



STANDING SEAM

Z-BAR FLASHING

Cladco Z-Bar Flashings are used in the installation of our Standing Seam Sheets as side cladding. These Flashings provide a secure area for our Corner Barge Flashings to be clamped upon, leaving a professional finish.

COLOUR RANGE



FLASHING SPECIFICATIONS

Length	3m
Dimensions	25mm x 29mm x 36mm
Thickness	0.7mm
External Finish	GreenCoat® Pural BT

TEST CERTIFICATIONS

Quality	CE Marked (BS EN 14783:2013)
Fire Rating	Class A1 (BS EN 13501)

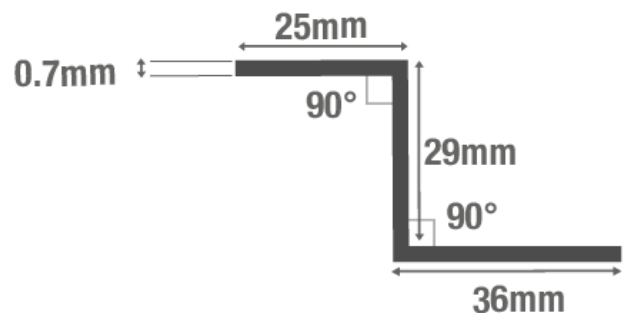

STANDING SEAM FLASHINGS FOR CLADDING

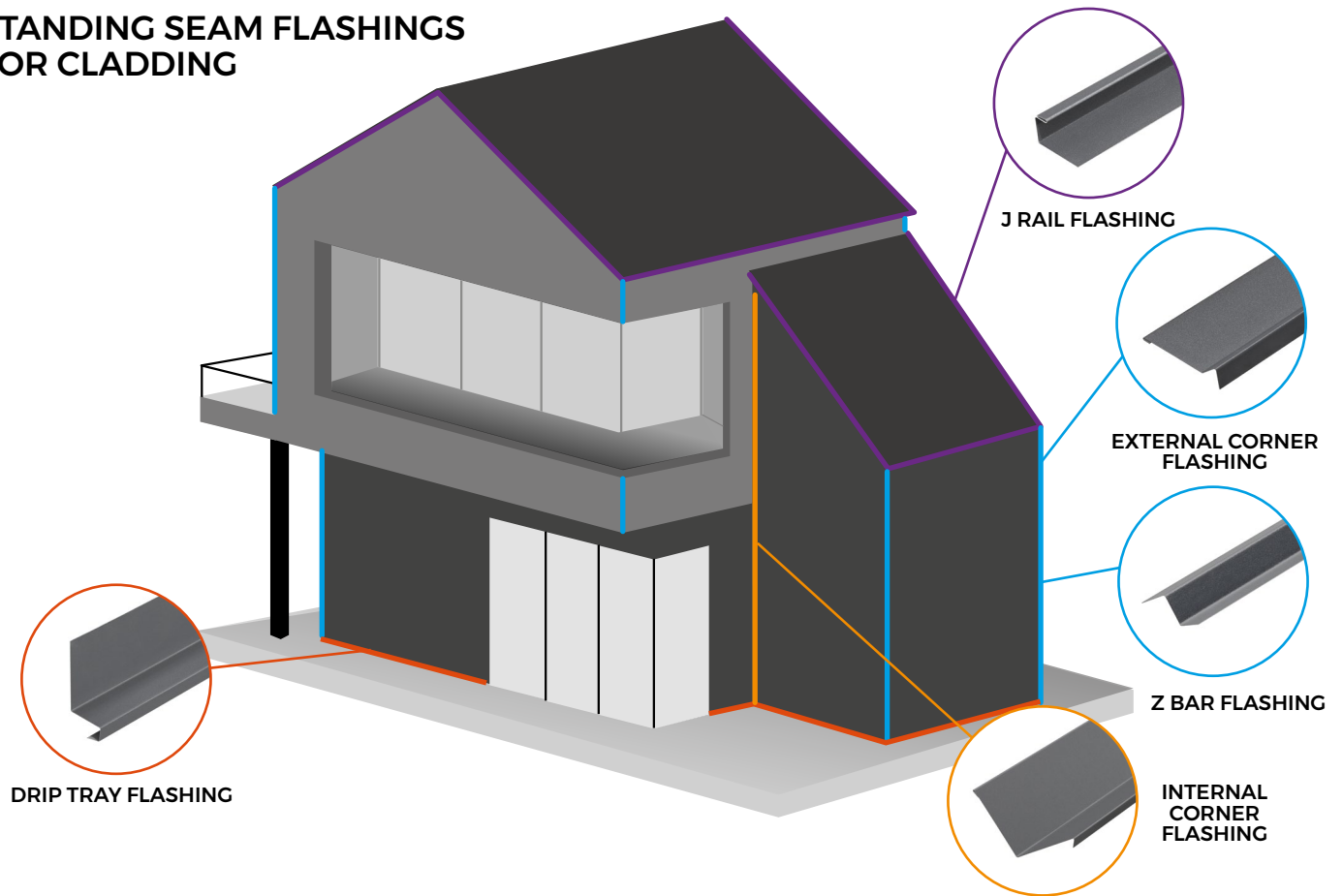

STANDING SEAM FLASHINGS FOR ROOFING

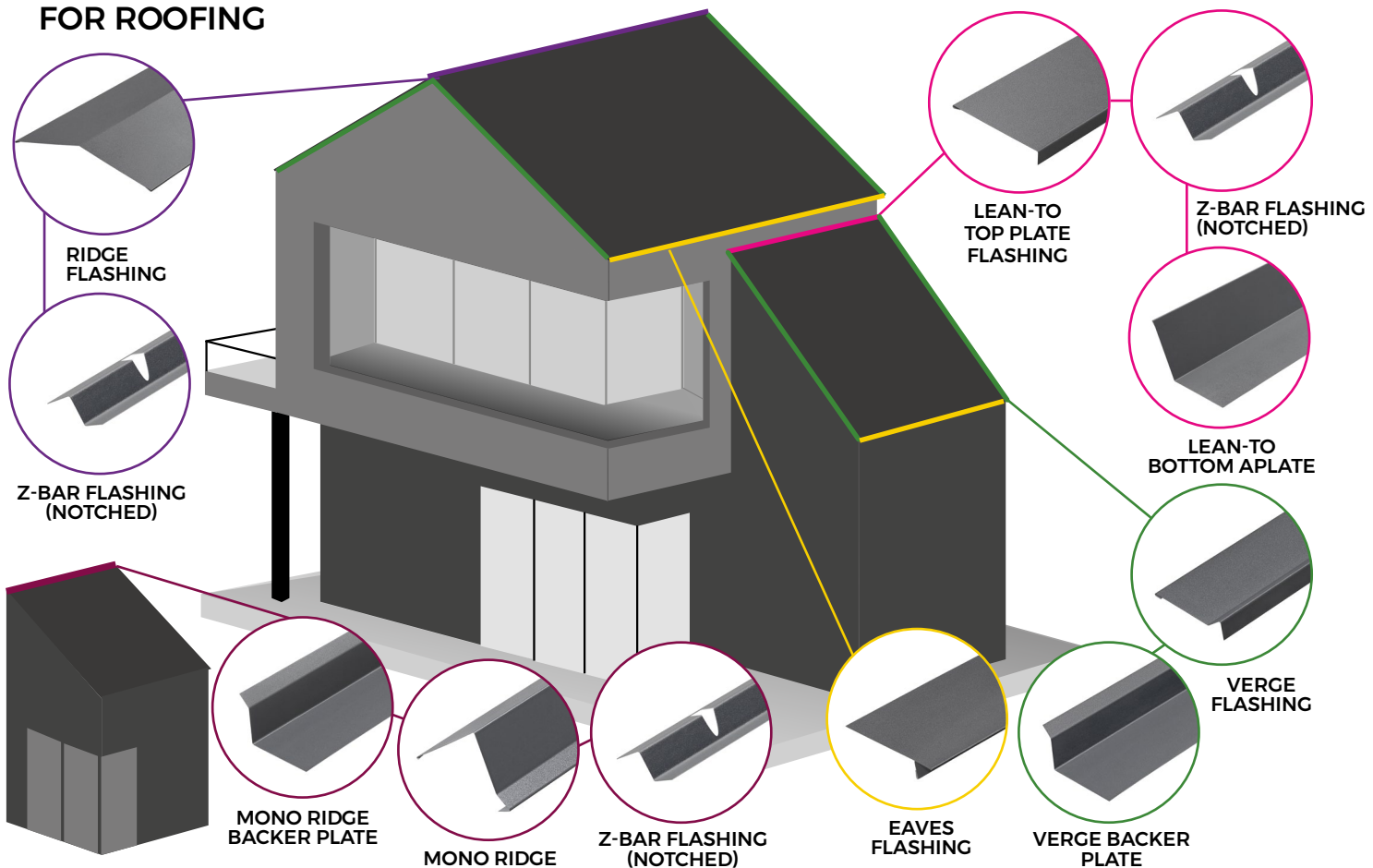

SUSTAINABLE MATERIALS

Cladco Standing Seam Roofing Sheets are manufactured from SSAB Steel coated with GreenCoat® Pural BT. The use of Swedish rapeseed oil, in place of traditional fossil fuel oils, promotes sustainable production methods which reduce our environmental footprint to provide you with a high-quality, A1 fire-rated roofing and cladding product.

AFTERCARE

Standing Seam Roof Sheets are low-maintenance and require little in the way of upkeep. We recommend, however, that annual inspection of the Sheeting is carried out, and any debris or dirt build up is removed or cleaned away.



Sustainable Coating Made From Swedish Rapeseed Oil



Made From High-Quality SSAB Nordic Quality Steel



Scratch, Corrosion And Weather Resistant Surface



Hidden Fixing With Annular Ring Nails



MATERIALS

Nordic quality, sustainable SSAB steel promotes sustainable production.



SURFACES

A durable GreenCoat® Pural BT coating with a matt finish, with or without ribs.



ACCESSORIES

Our Z-Bar Flashings are installed prior to our Corner Barge Flashings and Internal Corner Barge Flashings for cladding applications.



RESISTANCE

Pural BT coated Sheets are weather, corrosion, scratch and UV resistant.



GUARANTEE

Sheets have a long life span of up to 50 years.

PRODUCT ACCESSORIES

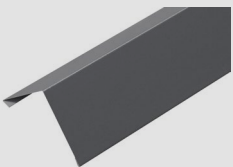

CORNER BARGE FLASHING

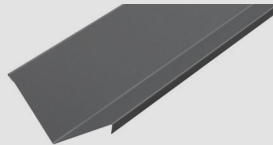

INTERNAL CORNER BARGE FLASHING



TIN SNIPS



ANNULAR RING NAILS



CTI ADHESIVE AND SEALANT

TOOLS REQUIRED



SEAMING PLIERS



HANDHELD CIRCULAR SAW



RUBBER MALLET

For a full list of tools required, please refer to our Standing Seam Installation Guide.

www.cladco.co.uk

T: 01837 659901 E: info@cladco.co.uk

CLADCO
PROFILES